

STEELCONSTRUCTION

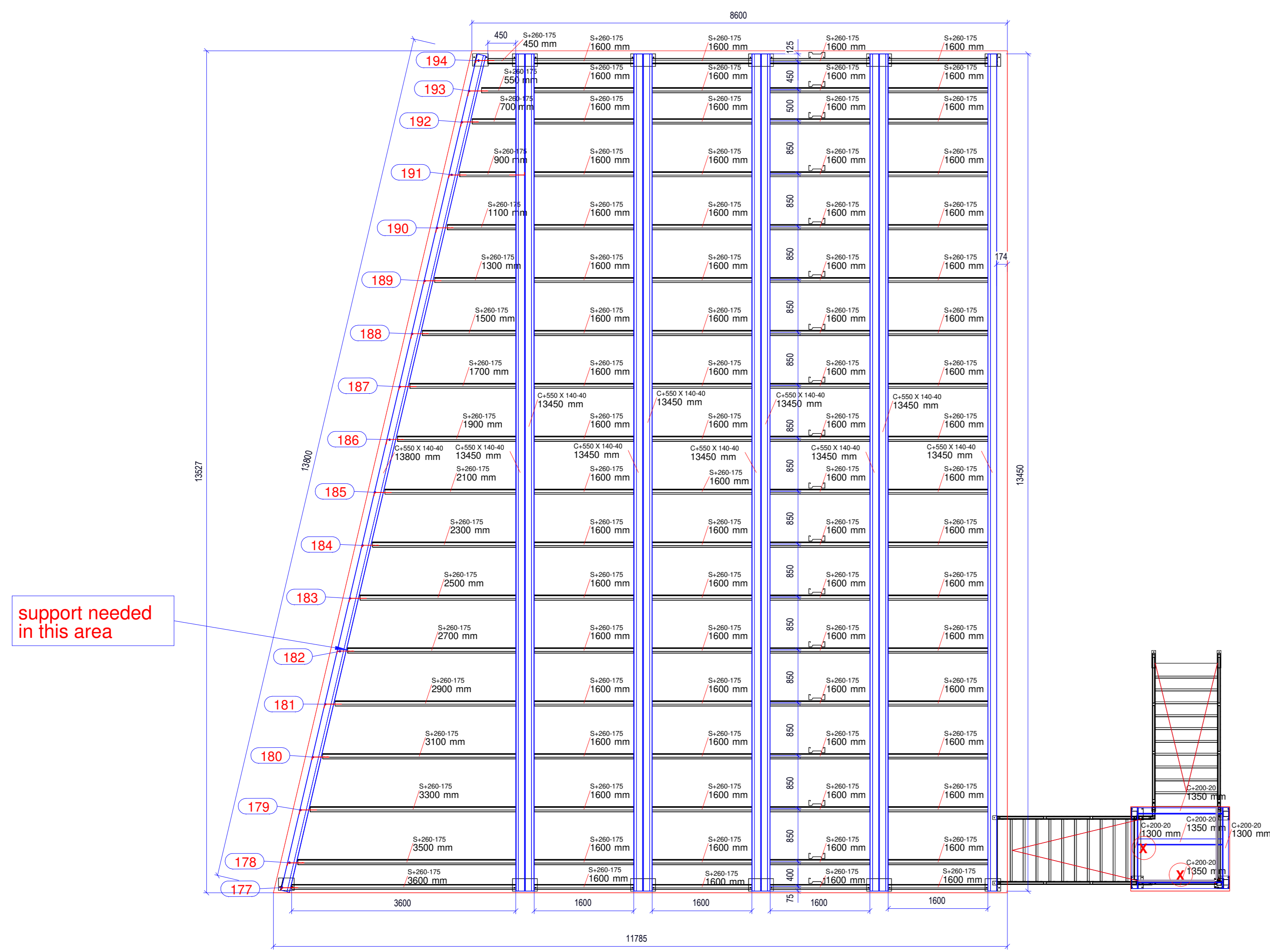

FLOOR DIMENSIONS

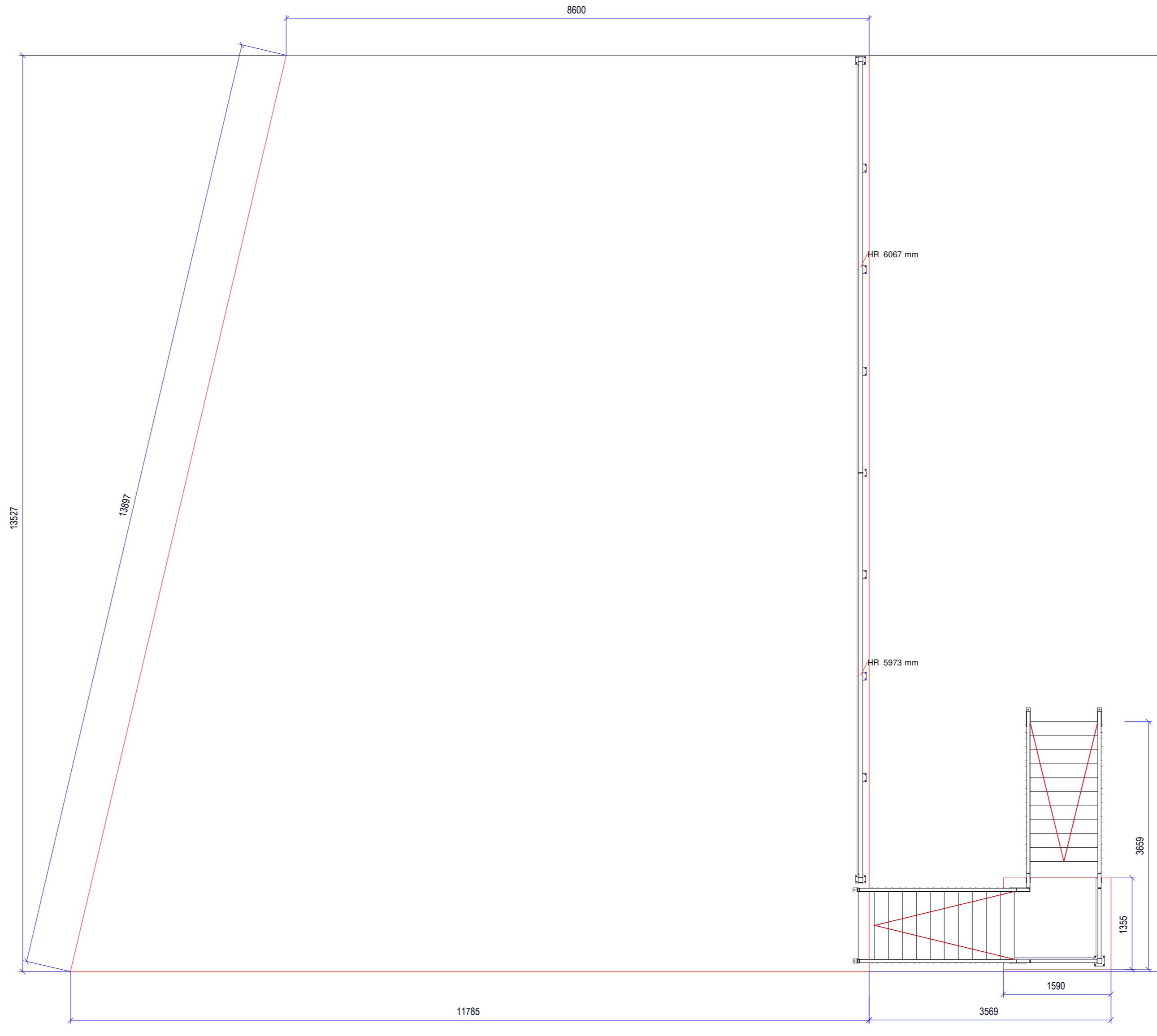

FLOOR BOARDS PLAN

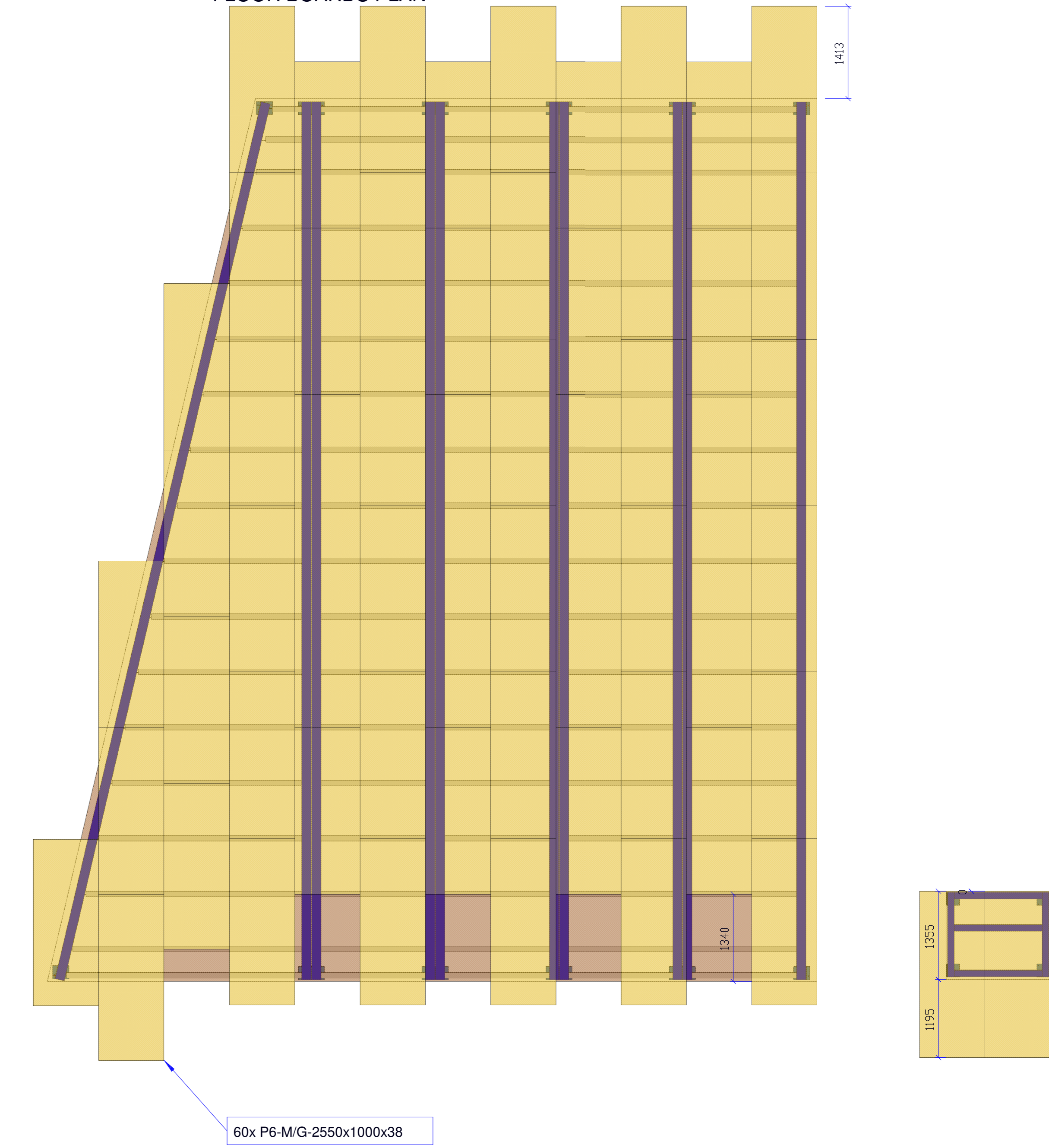

SIDE VIEW

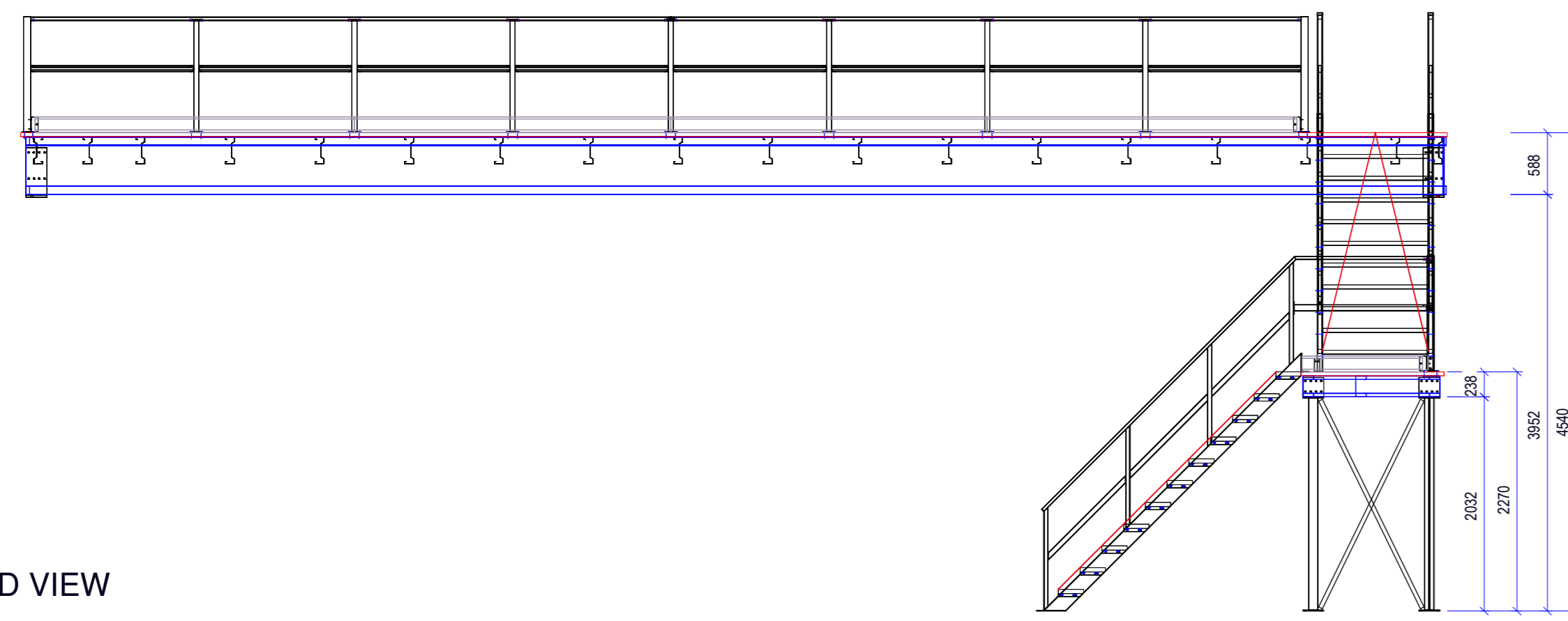

FRONT VIEW

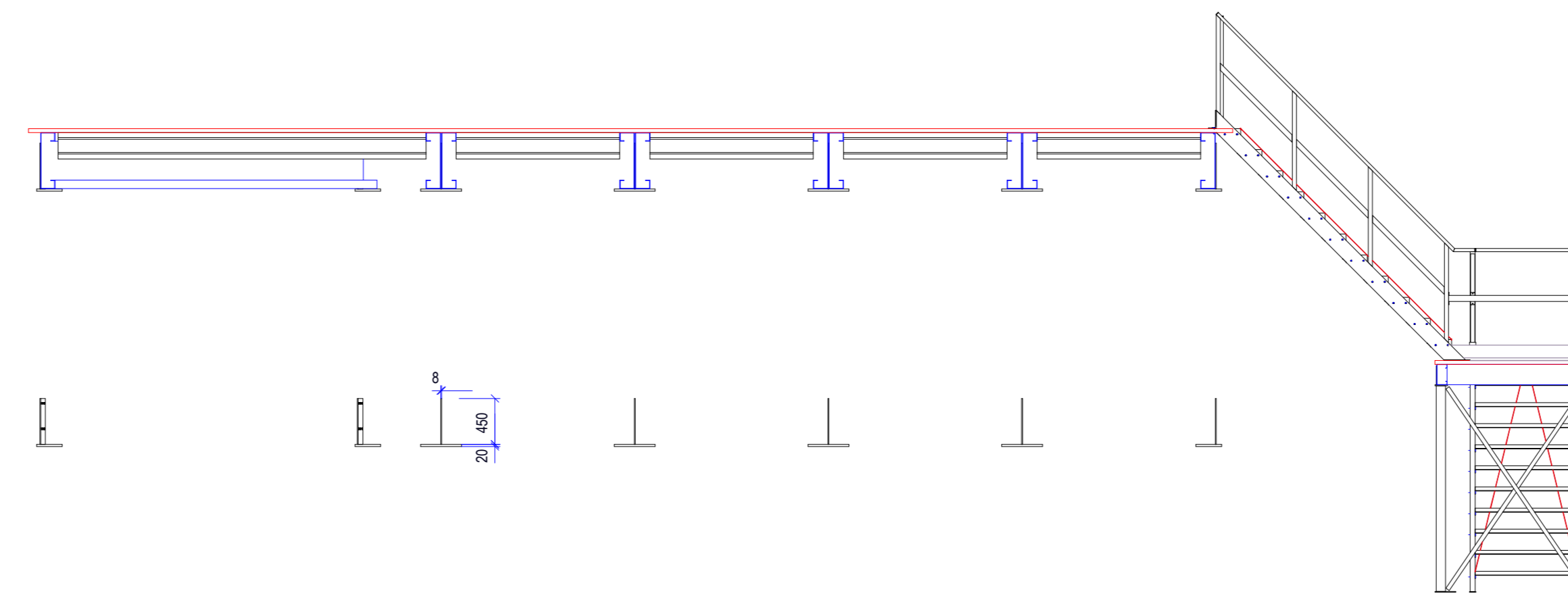

3D VIEW

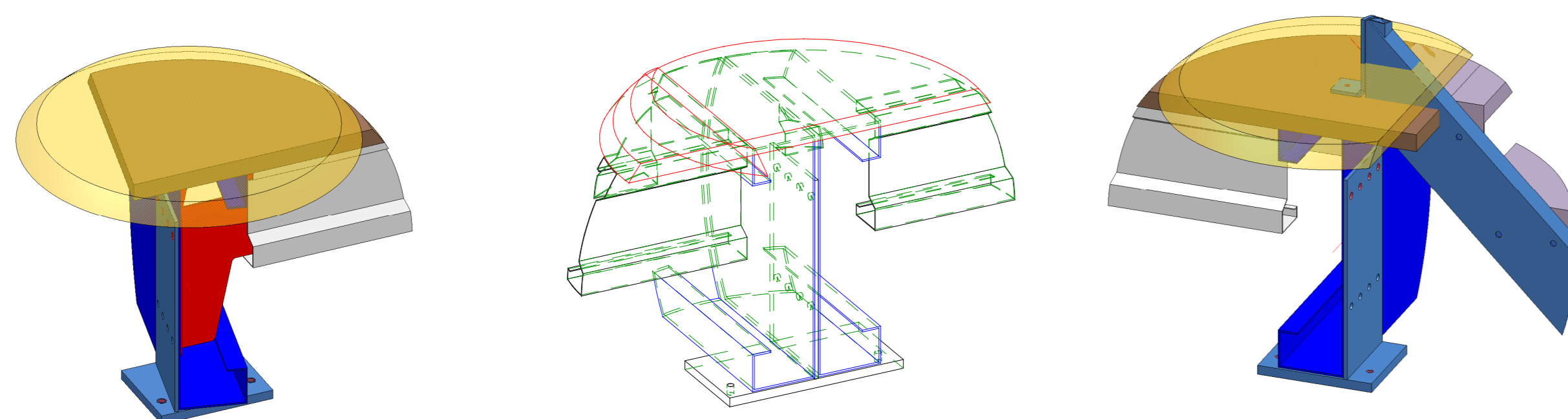
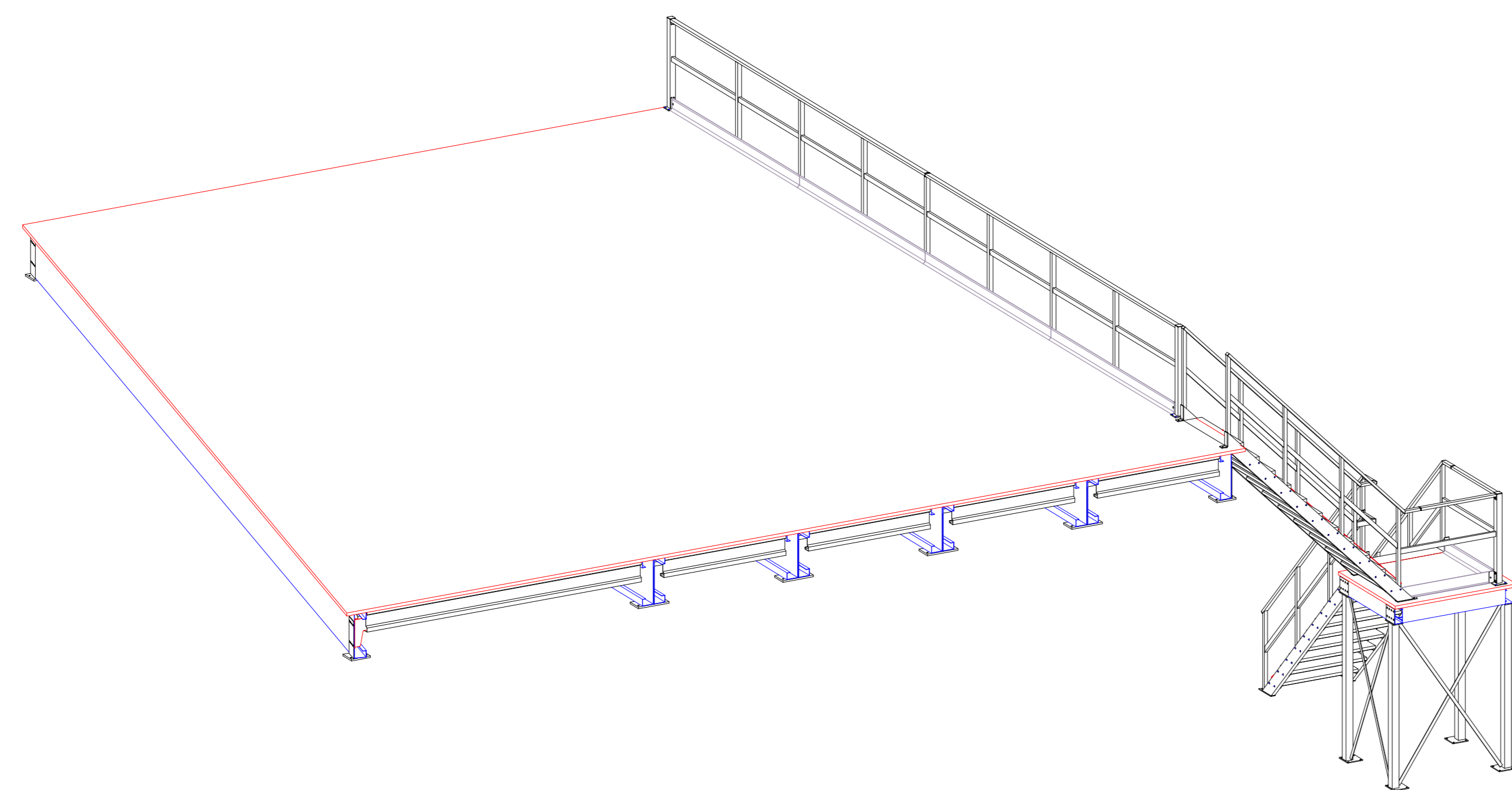

Hide punch in the profiles:	Hide punch in the profiles:	Raining profile:
COOP	COOP	COOP

SPECIFICATIONS	
Height top measure	4540 mm
Height under construction	3602 mm (incl. deflection of beams not included)
Total square of construction	138 m ²
Maximum load in kg/m ²	250 kg/m ²
Maximum pressure on Column	60 kN

PRODUCT SPECIFICATIONS	
Main beam	PFR CS90 CS90
Secondary beam	PFR CS90
Column	NA
Floorboard	FR (lightwood natural / white laminated, height 30mm)
Stair	SS - steel beam with hot dip galvanized grated steps, 1000mm, total width: 1100mm
Handrail	Steel, with hand- and knee rail CS90 and lock plate, height: 1100mm
Paint color	
Column	Roaming, bearings, hand- and knee rail: galvanized Columns, stairs, railing posts: RAL 7016

Hansa Schourup AIS Boven de Oudekerk 10 1118 CA Amsterdam, The Netherlands Tel: +31 (0) 20 481 1000 info@hansa-schourup.nl www.hansa-schourup.nl	
project: DK-6000 Aarhus C date: 20.02.2018 scale: 1:50 engineer: D.V. checked by:	Drawing no: 19.353.DK.W01 COPYRIGHT COLLAN SYSTEM